



US Micro Products
Electronic Products for the OEM

LCD PRODUCT SPECIFICATION

PART NUMBER:	USMPG-TQ19264C-TBYBH
DESCRIPTION:	128x128 Graphic LCD; STN Blue Display Mode; Transflective, Positive with Yellow-Green LED Backlight and 6 O'Clock Viewing Direction.

ISSUE DATE	APPROVED BY (Customer Use Only)	CHECKED BY	PREPARED BY
PROPRIETARY NOTE:	THIS SPECIFICATION IS THE PROPERTY OF US MICRO PRODUCTS AND SHALL NOT BE REPRODUCED OR COPIED WITHOUT THE WRITTEN PERMISSION OF US MICRO PRODUCTS AND MUST BE RETURNED TO US MICRO PRODUCTS UPON ITS REQUEST.		

1.Features

- a) 128x128 dots graphic LCD module
- b) Built-in controller (T6963C or Equivalent)
- c) Low power consumption
- d) Easy interface with 8-bit MPU
- e) +5V power supply
- f) 1/128 duty cycle
- g) Display mode: STN (Yellow-Green) , positive, transfective
- h) View andgle: 6:00
- i) LED sidelight: Yellow-Green color
- j) Building negative voltage

2.Outline dimension

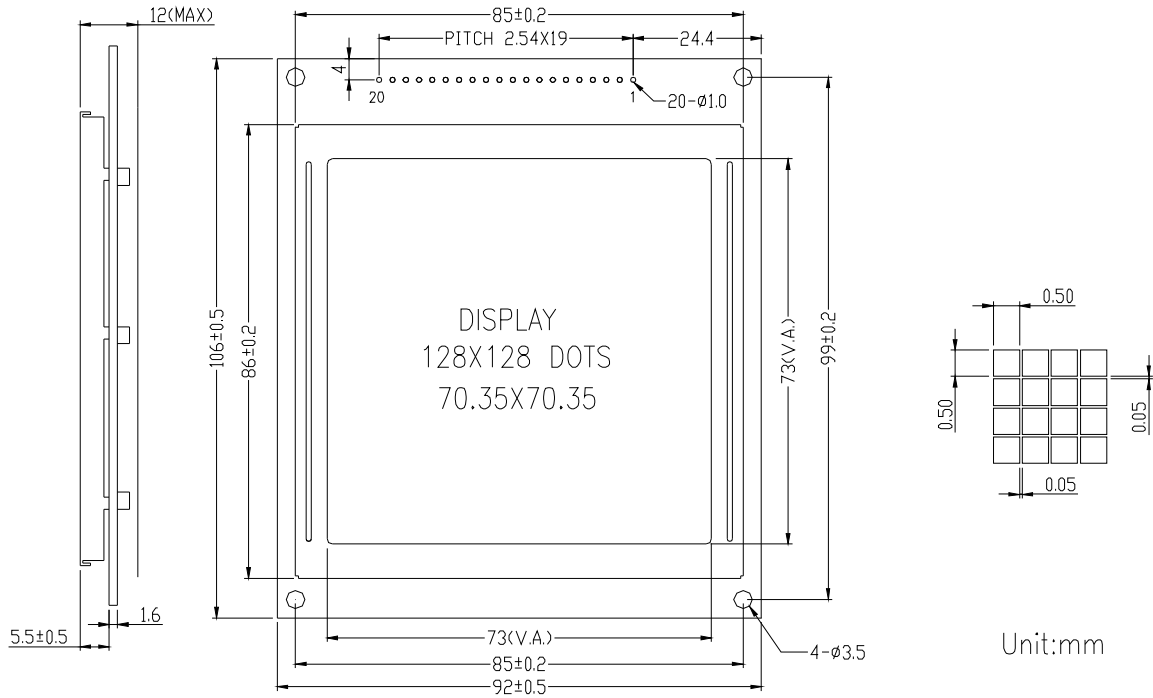

3.Absolute maximum ratings

Item	Symbol	Standard			Unit
Power voltage	V _{DD} -V _{SS}	-0.3	-	7.0	V
Input voltage	V _{IN}	-0.3	-	V _{DD} +0.3	
Operating temperature range	Top	-20	-	+70	°C
Storage temperature range	Tst	-30	-	+80	

4. Block diagram

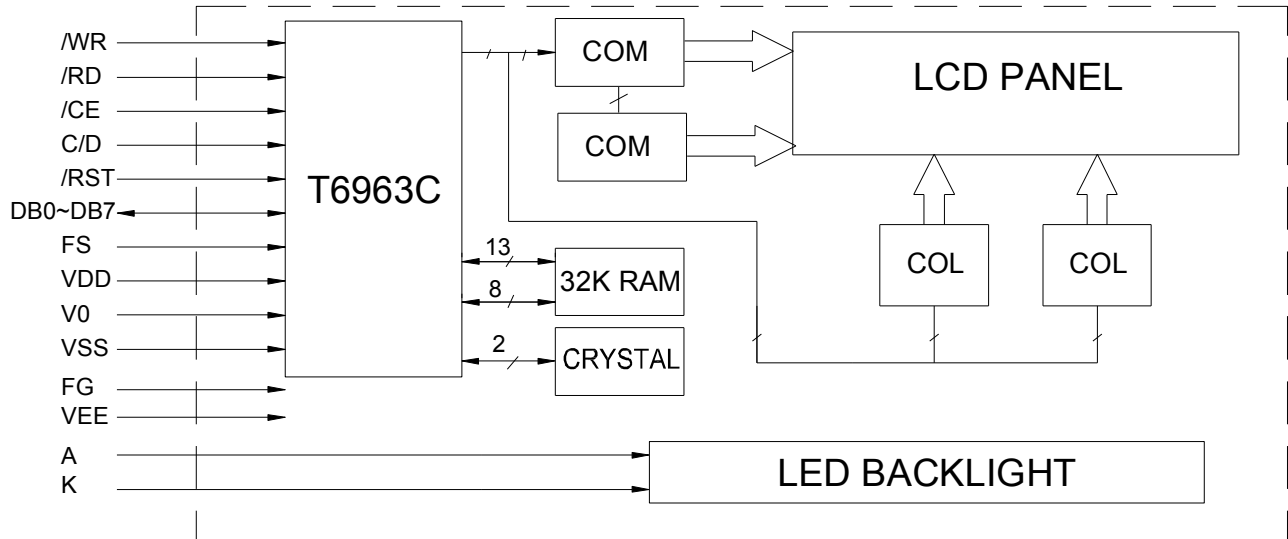

5. Interface pin description

Pin no.	Symbol	External connection	Function
1	FG		Frame ground
2	V _{SS}	Power supply	Signal ground for LCM (GND)
3	V _{DD}		Power supply for logic for LCM
4	V ₀		Operating voltage for LCD
5	/WR	MPU	Write enable signal
6	/RD	MPU	Read enable signal
7	/CE	MPU	Chip enable signal
8	C/D	MPU	H: Instruction L: Data
9	/RST	MPU	Reset signal
10~17	DB0~DB7	MPU	Data bus line
18	FS	MPU	Font selection
19	A	BKL power supply	Power supply for BKL (Anode)
20	K		Power supply for BKL (GND)

CONTRAST ADJUST

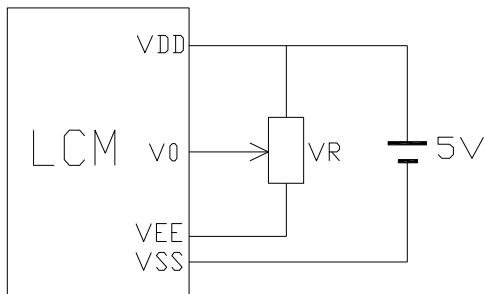

Building DC/DC

V_{DD}-V₀: LCD Driving voltage
VR: 10k~20k

CONFIDENTIAL

6. Optical characteristics

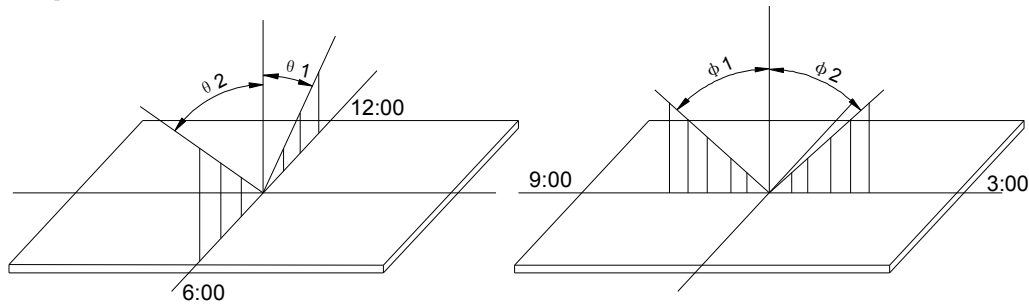

STN type display module (Ta=25°C, VDD=5.0V)

Item	Symbol	Condition	Min.	Typ.	Max.	Unit
Viewing angle	$\theta 1$	$C_r \geq 3$		20		deg
	$\theta 2$			40		
	$\Phi 1$			35		
	$\Phi 2$			35		
Contrast ratio	C_r		-	10	-	-
Response time (rise)	T_r	-	-	200	250	ms
Response time (fall)	T_r	-	-	300	350	

8. Electrical characteristics

Ø DC characteristics

Parameter	Symbol	Conditions	Min.	Typ.	Max.	Unit
Supply voltage for LCD	$V_{DD}-V_0$	Ta =25°C	—	16.5	—	V
Input voltage	V_{DD}		4.7	5.0	5.5	
Supply current	I_{DD}	Ta=25°C, VDD=5.0V	—	20	—	mA
Input leakage current	I_{LKG}		—	—	1.0	uA
“H” level input voltage	V_{IH}		2.2	—	V_{DD}	V
“L” level input voltage	V_L	Twice initial value or less	0	—	0.6	
“H” level output voltage	V_{OH}	LOH=-0.25mA	2.4	—	—	
“L” level output voltage	V_{OL}	LOH=1.6mA	—	—	0.4	
Backlight supply voltage	V_F		—	5.0	—	
Backlight supply current	I	Ta =25°C ,R=20 ohm	—	50	—	mA

Ø Switching characteristics

(Ta=25°C, VDD=5.0V)

Item	Symbol	Test conditions	Min.	Typ.	Max.	Unit
C/D set-up time	T_{cds}	—	100	—	—	ns
C/D hold time	T_w		10	—	—	
/CE, /RD, /WR pulse width	T_{ce}, T_{rd}, T_{wr}		80	—	—	
Data set-up time	T_{ds}		80	—	—	
Data hold time	T_{dh}		40	—	—	
Access time	T_{acc}		—	—	150	
Output hold time	T_{oh}		10	—	50	

CONFIDENTIAL

Bus timing diagram

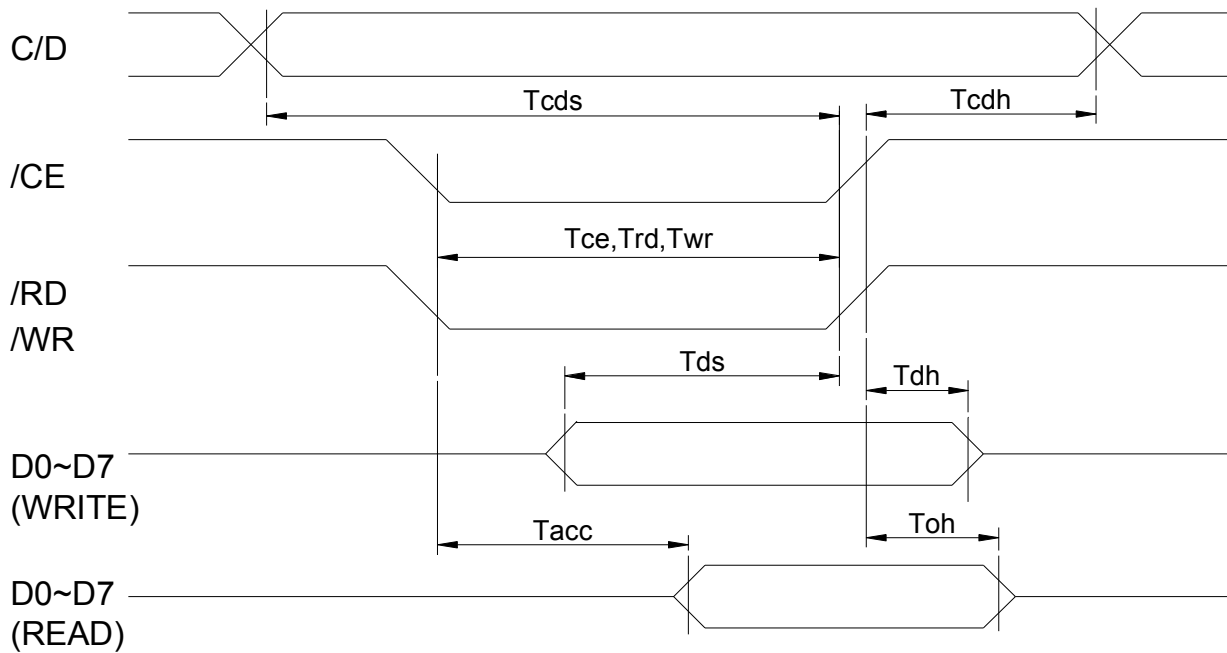

9.Flowchart of communications with MPU

Status read

A status check must be performed before data is read or written. The status word format is as follows:

/RD	/WR	/CE	C/D	STA7	STA5	STA5	STA4	STA3	STA2	STA1	STA0
0	1	0	1	DB7	DB6	DB5	DB4	DB3	DB2	DB1	DB0

STA	Description	0: disable	1:enable
STA0	Check command execution capability	0: disable	1:enable
STA1	Check data read / write capability	0: disable	1:enable
STA2	Check auto mode data read capability	0: disable	1:enable
STA3	Check auto mode data write capability	0: disable	1:enable
STA4	Not used		
STA5	Check controller operation capability	0: disable	1:enable
STA6	Error flag. Used for screen peek and screen copy commands.	0: no error	1: error
STA7	Check the blink condition	0: display off	1: normal display

Notes:

1. It is necessary to check STA0 and STA1 at the same time. There is a possibility of erroneous operation due to a hardware interrupt.
2. For most modes STA0 / STA1 are used as a status check.
3. STA2 and STA3 are valid in auto mode; STA0 and STA1 are invalid.
4. When using the STA7=0 command, a status read must be performed. If a status check is not carried out, the T6963C cannot operate normally, even after a delay time. The hardware interrupt occurs during the address calculation period (at the end of each line). If a STA7=0 command is sent to the T6963c during this period, the T6963C enters wait status. If a status check is not carried out in this state before the next command is sent, there is the possibility that the command or data will not be received.

CONFIDENTIAL

Setting data

When using the T6963C, first set the data, and then set the command. Procedure for sending a command:

a). The case of 1 data

b) the case of 2 data

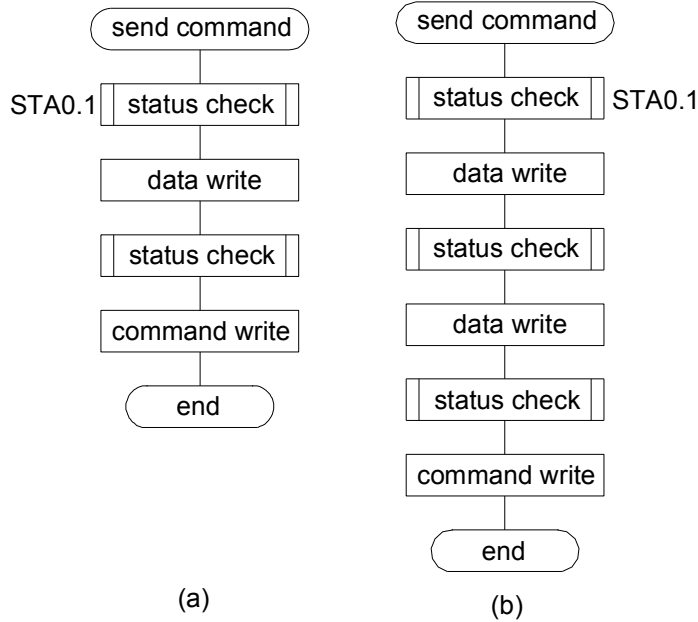

Note:

When sending more than two data, the last datum (or last two data) is valid.

CONFIDENTIAL

10.Command definitions

Command	Code	D1	D2	Function
Registers setting	00100001	X address	Y address	Set cursor pointer
	00100010	Data	00H	Set offset register
	00100100	Low address	High address	Set address pointer
Set control word	01000000	Low address	High address	Set text home address
	01000001	columns	00H	Set text area
	01000010	Low address	High address	Set graphic home address
	01000011	columns	00H	Set graphic area
Mode set	1000X000			OR mode
	1000X001			EXOR mode
	1000X011			AND mode
	1000X100			Text attribute mode
	10000XXX			Internal CG ROM mode
	10001XXX			External CG RAM mode
Display mode	10010000			Display off
	1001XX10			Cursor on, blink off
	1001XX11			Cursor on, blink on
	100101XX			Text on, graphic off
	100110XX			Text off, graphic on
	100111XX			Text on, graphic on
Cursor pattern select	10100000			1- Line cursor
	10100001			2- Line cursor
	10100010			3- Line cursor
	10100011			4- Line cursor
	10100100			5- Line cursor
	10100101			6- Line cursor
	10100110			7- Line cursor
	10100111			8- Line cursor
Data auto read / write	10110000			Set data auto write
	10110001			Set data auto read
	10110010			Auto reset
Data read / write	11000000	Data		Data write and increment ADP
	11000001			Data read and increment ADP
	11000010	Data		Data write and decrement ADP
	11000011			Data read and decrement ADP
	11000100	Data		Data write and no variable ADP
	11000101			Data read and no variable ADP
Screen peek	11100000			Screen peek
Screen copy	11101000			Screen copy
Bit set / reset	11110XXX			Bit reset
	11111XXX			Bit set
	1111X000			Bit 0 (LSB)
	1111X001			Bit 1
	1111X010			Bit 2
	1111X011			Bit 3
	1111X100			Bit 4
	1111X101			Bit 5
	1111X110			Bit 6
	1111X111			Bit 7(MSB)

Note:

When an MPU program with checking the busy flag (DB7) is made, it must be necessary 1/2fosc is necessary for executing the next instruction by the falling edge of the "E" signal after the busy flag (DB7) goes to "Low".

X: invalid

Contents

1). Setting registers

CONFIDENTIAL

D1	D2	DB7	DB6	DB5	DB4	DB3	DB2	DB1	DB0
X	X	0	0	1	0	0	N2	N1	N0

CODE	HEX.	FUNCTION	D1	D2
00100001	21H	Set cursor pointer	X ADRS	Y ADRS
00100010	22H	Set offset register	DATA	00H
00100100	24H	Set address pointer	Low ADRS	High ADRS

Ø Set cursor pointer

X ADRS and Y ADRS specify the position or the cursor. The cursor position can only be moved by this command. Data read / write from the MPU never changes the cursor pointer.

X ADRS and Y ADRS are specified as follows.

X ADRS 00H to 4FH (lower 7 bits are valid)

Y ADRS 00H to 1FH (lower 5 bits are valid)

a) Single-scan

X ADRS 00H to 4FH

Y ADRS 00H to 0FH

b) Dual-scan

X ADRS 00H to 4FH

Y ADRS 00H to 0FH(upper screen)

Y ADRS 10H to 1FH(lower screen)

Ø Set offset register

The offset register is used to determine the external character generator RAM area.

The T6963C has a 16-bit address bus as follows:

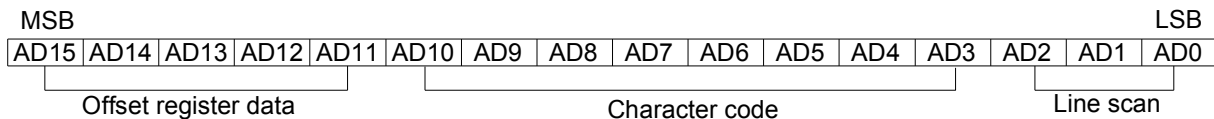

T6963C assign external character generator, when character code set 80H to FFH in using internal character generator. Character code 00H to 80H assign External character generator, when External generator mode.

The senior five bits define the start address in external memory of the CGRAM area. The next eight bits represent the character code of the character. In internal CGRAM mode, character codes 00H to 7FH represent the predefined "internal" CGRAM characters, and codes 80H to FFH represent the user's own "external" characters. In external CGRAM mode, all 256 codes from indicate one of the eight rows of eight dots that define the character's shape.

The relationship between display RAM address and offset register

Ø Set address pointer

The set address pointer command is used to indicate the start address for writing to (or reading from) external RAM.

The flowchart for set address pointer command:

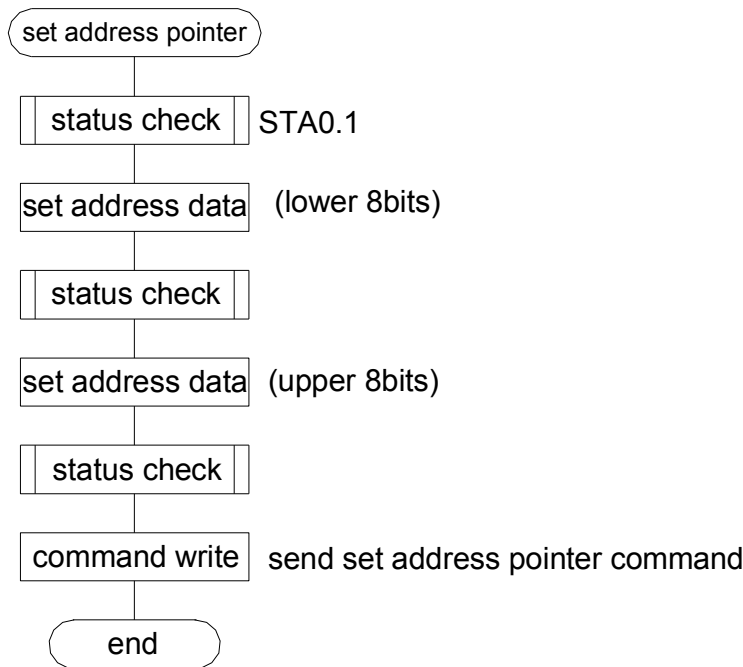

2). Set control word

D1	D2	DB7	DB6	DB5	DB4	DB3	DB2	DB1	DB0
X	X	0	1	0	0	0	0	N1	N0

CODE	HEX.	FUNCTION	D1	D2
01000000	40H	Set text home address	Low address	High address
01000001	41H	Set text area	Columns	00H
01000010	42H	Set graphic home address	Low address	High address
01000000	43H	Set graphic area	Columns	00H

The home address and column size are defined by this command.

Ø Set text home address

The starting address in the external display RAM for text display is defined by this command.

The text home address indicates the leftmost and uppermost position.

The relationship between external display RAM address and display position

TH		TH +CL
TH+TA		TH+TA+CL
(TH+TA)+TA		TH+2TA+CL
(TH+2TA)+TA		TH+3TA+CL
/		/
TH+(N-1) TA		TH+(N-1) TA+CL

TH: text home address

TA: text area number (columns)

CL: columns ate fixed by hardware (pin-programmable)

Ø Set graphic home address

The starting address of the external display RAM used for graphic display is defined by this command. The graphic home address indicates the leftmost and uppermost position.

CONFIDENTIAL

The relationship between external display RAM address and display position

GH		GH +CL
GH+GA		GH + GA +CL
(GH+ GA)+ GA		GH +2 GA +CL
(GH +2 GA)+ GA		GH +3 GA +CL
/		/
GH +(N-1) GA		GH +(N-1) GA +CL

GH: Graphic home address

GA: Graphic area number (columns)

CL: columns ate fixed by hardware (pin-programmable)

Ø Set text area

The display columns are defined by the hardware setting. This command can be used to adjust the columns of the display.

Ø Set graphic area

The display columns are defined by the hardware setting. This command can be used to adjust the columns of the graphic display.

If the graphic area setting is set to match the desired number of columns on the LCD, the addressing scheme will be automatically modified so that the start address of each line equals the end address of the previous line +1.

3). Mode set

CODE	FUNCTION	OPERAND
1000X000	OR Mode	—
1000X001	EXOR Mode	—
1000X011	AND Mode	—
1000X100	TEXT Attribute Mode	—
10000XXX	Internal character Mode	—
10001XXX	External character Mode	—

The display mode is defined by this command. The display mode does not change until the next command is sent. The logical OR, EXOR, AND of text or graphic display can be displayed.

In internal character generator mode, character codes 00H to 7FH are assigned to the built-in character generator ROM. The character codes 80H to FFH are automatically assigned to the external character generator RAM.

NOTE: attribute functions can only be applied to text display, since the attribute data is placed in the graphic RAM area.

Attribute function

The attribute operations are reverse display, character blink and inhibit. The attribute data is written into the graphic area, which was defined by the set control word command. Only text display is possible in attribute function mode; graphic display is automatically disabled. However, the display mode command must be used to turn both text and graphic on in order for the attribute function to be available.

The attribute data for each character in the text area is written to the same address in the graphic area. The attribute function is defined as follows.

Attribute RAM 1byte

X	X	X	X	DB3	DB2	DB1	DB0
---	---	---	---	-----	-----	-----	-----

CONFIDENTIAL

DB3	DB2	DB1	DB0	FUNCTION
0	0	0	0	Normal display
0	1	0	1	Reverse display
0	0	1	1	Inhibit display
1	0	0	0	Blink of normal display
1	1	0	1	Blink of reverse display
1	0	1	1	Blink of inhibit display

4). Display mode

CODE	FUNCTION	OPERAND
10010000	Display off	——
1001xx10	Cursor on, blink off	——
1001xx11	Cursor on, blink on	——
100101xx	Text on, graphic off	——
100110xx	Text off, graphic on	——
100111xx	Text on, graphic on	——

1	0	0	1	DB3	DB2	DB1	DB0
---	---	---	---	-----	-----	-----	-----

DB0: cursor blink on: 1 off: 0
 DB1: cursor display on: 1 off: 0
 DB2: text display on: 1 off: 0
 DB3: graphic display on: 1 off: 0

NOTE:

It is necessary to turn on “text display” and “graphic display” in the following cases.

- a) Combination of text / graphic display
- b) Attribute function

5). Cursor pattern select

CODE	FUNCTION	OPERAND
10100000	1-line cursor	
10100001	2-line cursor	
10100010	3-line cursor	
10100011	4-line cursor	
10100100	5-line cursor	
10100101	6-line cursor	
10100110	7-line cursor	
10100111	8-line cursor	

When cursor display is on, this command selects the cursor pattern in the range 1 line to 8 lines. The cursor pointer set command defines the cursor address.

6). Data auto read / write

CODE	HEX.	FUNCTION	OPERAND
10110000	B0H	Set data auto write	—
10110001	B1H	Set data auto read	—
10110010	B2H	Auto rest	—

The command is convenient for sending a full screen of data from the external display RAM. After setting auto mode, a data write (or read) command is need not be sent between each datum. A data auto write (or read) command must be send after a set address pointer command. After this command, the address pointer is automatically incremented by 1 after each datum. In auto mode, the T6963C cannot accept any other commands.

The auto reset command must be sent to the T6963C after all data has been sent, to clear auto mode.

NOTE: A status check for auto mode (STA2, STA3 should be checked between sending of each datum. Auto reset should be performed after checking STA3=1(STA2=1)). Refer to the following flowchart.

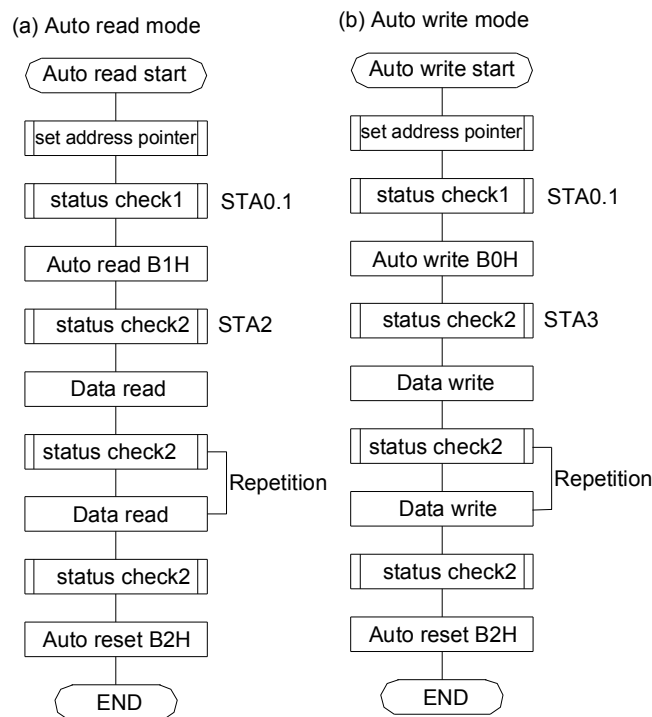

7). Data read / write

CODE	HEX.	FUNCTION	OPERAND
11000000	C0H	Data write and increment ADP	Data
11000001	C1H	Data read and increment ADP	—
11000010	C2H	Data write and decrement ADP	Data
11000011	C3H	Data read and decrement ADP	—
11000100	C4H	Data write and no variable ADP	Data
11000101	C5H	Data read and no variable ADP	—

This command is used for writing data from the MPU to external display RAM, and reading data from external display RAM to the MPU. Data write /data read should be executed after

CONFIDENTIAL

setting address using ser address pointer command. The address pointer can be automatically incremented or decremented using this command.

Note: this command is necessary for each 1-byte datum. Refer to the following flowchart.

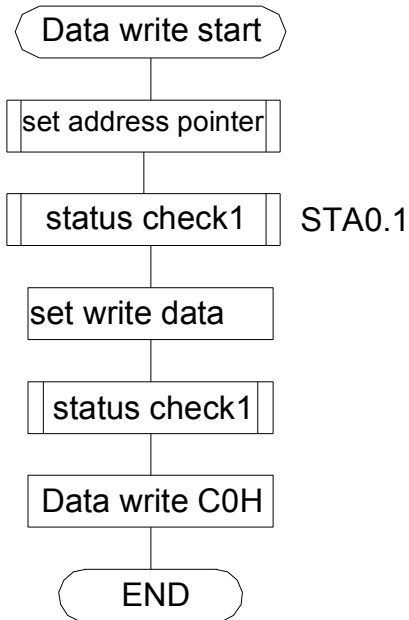

8). Screen peek

CODE	HEX.	FUNCTION	OPERAND
11100000	E0H	Screen peek	—

This command is used to transfer 1 byte of displayed data to the data stack; this byte can then be read from the MPU by data access. The logical combination of text and graphic display data on the LCD screen can be read by read by this command.

The status (STA6) should be checked just after the screen peek command. If the address determined by the set address pointer command is not in the graphic area, this command is ignored and a status flag (STA6) is set.

Refer to the following flowchart.

CONFIDENTIAL

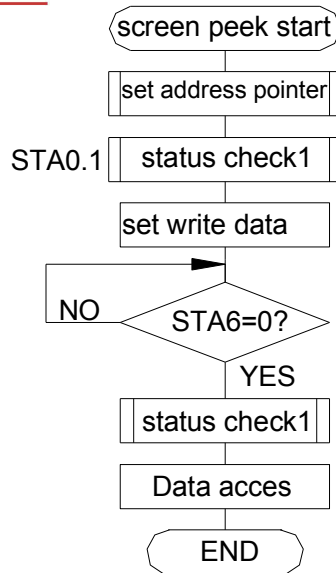

Note: this command is available when hardware column number and software column number are the same. Hardware column number is related to MD2 and MD3 setting. Software column number is related to ser text area and set graphic area command.

9). Screen copy

CODE	HEX.	FUNCTION	OPERAND
11101000	E8H	Screen copy	—

This command copies a raster line of data to the graphic area. The start point must be set using the set address pointer command.

Note:

If the attribute function is being used, this command is not available. (With attribute data is graphic area data.)

With dual-scan, this command cannot be used (because the T6963C cannot separate the upper screen data and lower screen data). Refer to the following flowchart.

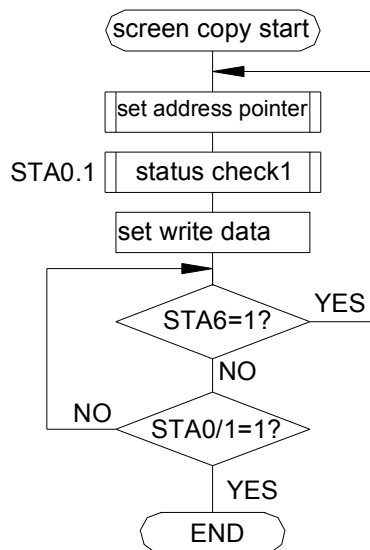

This command is available when hardware column number and software column number

are the same. Hardware column number is related to MD2 and MD3 setting. Software column number is related to set text area and set graphic area command.

10). Bit set /reset

CODE	FUNCTION	OPERAND
11110XXX	Bit reset	---
11111XXX	Bit set	---
1111X000	Bit 0 (LSB0)	---
1111X001	Bit 1	---
1111X010	Bit 2	---
1111X011	Bit 3	---
1111X100	Bit 4	---
1111X101	Bit 5	---
1111X110	Bit 6	---
1111X111	Bit 7 (LSB0)	---

This command use to set or reset a bit of the byte specified by the address pointer. Only one bit can be set / reset at a time. Refer to the following flowchart.

CONFIDENTIAL

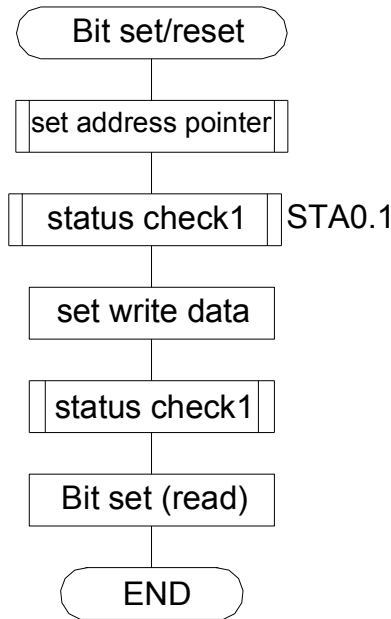

11. Quality Specifications

11.1 STANDARD OF THE PRODUCT APPEARANCE TEST

Manner of appearance test: The inspection should be performed in using 20W x 2 fluorescent lamps. Distance between LCM and fluorescent lamps should be 100 cm or more. Distance between LCM and inspector eyes should be 25 cm or more.

Viewing direction for inspection is 35° from vertical against LCM.

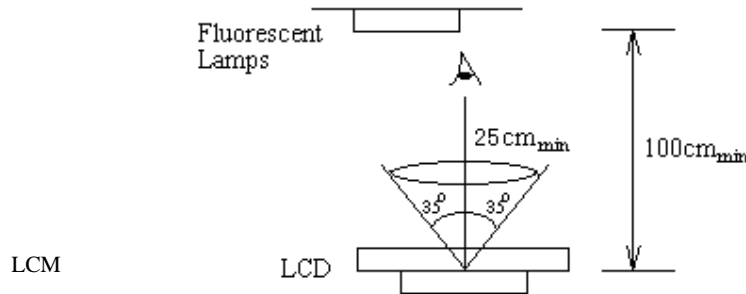

Definition of zone:

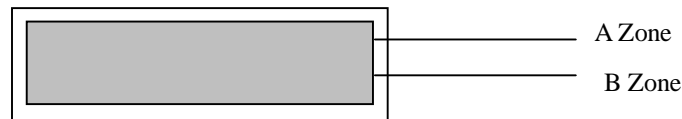

A Zone: Active display area (minimum viewing area).

B Zone: Non-active display area (outside viewing area).

11.2 SPECIFICATION OF QUALITY ASSURANCE

AQL inspection standard

Sampling method: GB2828-87, Level II, single sampling

Defect classification (**Note: * is not including**)

Classify		Item	Note	AQL
Major	Display state	Short or open circuit	1	0.65
		LC leakage		
		Flickering		
		No display		
		Wrong viewing direction		
		Contrast defect (dim, ghost)		
	Backlight	1,8		
	Non-display	Flat cable or pin reverse	10	
Wrong or missing component		11		
Minor	Display state	Background color deviation	2	1.0
		Black spot and dust	3	
		Line defect, Scratch	4	
		Rainbow	5	
		Chip	6	
		Pin hole	7	
		Protruded	12	
	Polarizer	Bubble and foreign material	3	
	Soldering	Poor connection	9	
	Wire	Poor connection	10	
	TAB	Position, Bonding strength	13	

CONFIDENTIAL

Note on defect classification

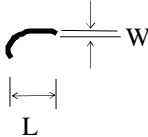
No.	Item	Criterion												
1	Short or open circuit	Not allow												
	LC leakage													
	Flickering													
	No display													
	Wrong viewing direction													
	Wrong Back-light													
2	Contrast defect	Refer to approval sample												
	Background color deviation													
3	Point defect, Black spot, dust (including Polarizer) $\phi = (X+Y)/2$	 <table border="1" data-bbox="873 823 1279 1054"> <thead> <tr> <th>Point Size</th> <th>Acceptable Qty.</th> </tr> </thead> <tbody> <tr> <td>$\phi \leq 0.10$</td> <td>Disregard</td> </tr> <tr> <td>$0.10 < \phi \leq 0.15$</td> <td>2</td> </tr> <tr> <td>$0.15 < \phi \leq 0.25$</td> <td>1</td> </tr> <tr> <td>$\phi > 0.25$</td> <td>0</td> </tr> </tbody> </table> <p style="text-align: center;">Unit: Inch²</p>	Point Size	Acceptable Qty.	$\phi \leq 0.10$	Disregard	$0.10 < \phi \leq 0.15$	2	$0.15 < \phi \leq 0.25$	1	$\phi > 0.25$	0		
Point Size	Acceptable Qty.													
$\phi \leq 0.10$	Disregard													
$0.10 < \phi \leq 0.15$	2													
$0.15 < \phi \leq 0.25$	1													
$\phi > 0.25$	0													
4	Line defect, Scratch	 <table border="1" data-bbox="808 1276 1318 1444"> <thead> <tr> <th colspan="2">Line</th> <th rowspan="2">Acceptable Qty.</th> </tr> <tr> <th>L</th> <th>W</th> </tr> </thead> <tbody> <tr> <td>---</td> <td>$0.05 > W$</td> <td rowspan="3">Disregard</td> </tr> <tr> <td>$3.0 > L$</td> <td>$0.1 > W > 0.05$</td> </tr> <tr> <td>$2.0 > L$</td> <td>$0.15 \geq W > 0.1$</td> </tr> </tbody> </table> <p style="text-align: center;">Unit: mm</p>	Line		Acceptable Qty.	L	W	---	$0.05 > W$	Disregard	$3.0 > L$	$0.1 > W > 0.05$	$2.0 > L$	$0.15 \geq W > 0.1$
Line		Acceptable Qty.												
L	W													
---	$0.05 > W$	Disregard												
$3.0 > L$	$0.1 > W > 0.05$													
$2.0 > L$	$0.15 \geq W > 0.1$													
5	Rainbow	Not more than two color changes across the viewing area.												

CONFIDENTIAL

CONFIDENTIAL

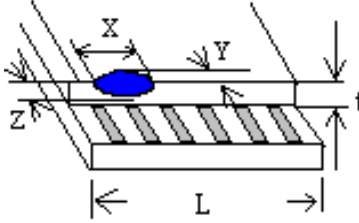
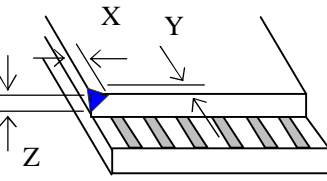
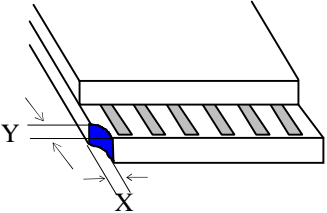
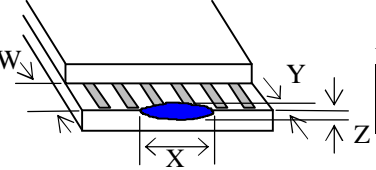
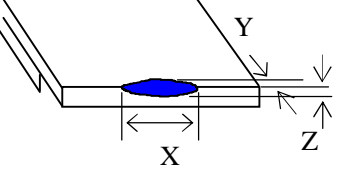
No	Item	Criterion							
6	<p>Chip</p> <p>Remark: X: Length direction Y: Short direction Z: Thickness direction t: Glass thickness W: Terminal width L: Glass length</p>	 <p>Acceptable criterion</p> <table border="1"> <thead> <tr> <th>X</th> <th>Y</th> <th>Z</th> </tr> </thead> <tbody> <tr> <td>$< L/8$</td> <td>0.5mm</td> <td>$\leq t/2$</td> </tr> </tbody> </table>	X	Y	Z	$< L/8$	0.5mm	$\leq t/2$	
		X	Y	Z					
		$< L/8$	0.5mm	$\leq t/2$					
		 <p>Acceptable criterion</p> <table border="1"> <thead> <tr> <th>X</th> <th>Y</th> <th>Z</th> </tr> </thead> <tbody> <tr> <td>≤ 2</td> <td>0.5mm</td> <td>$\leq t$</td> </tr> </tbody> </table>	X	Y	Z	≤ 2	0.5mm	$\leq t$	
		X	Y	Z					
≤ 2	0.5mm	$\leq t$							
 <p>Acceptable criterion</p> <table border="1"> <thead> <tr> <th>X</th> <th>Y</th> <th>Z</th> </tr> </thead> <tbody> <tr> <td>≤ 3</td> <td>≤ 2</td> <td>$\leq t$</td> </tr> <tr> <td colspan="2">shall not reach to ITO</td> <td></td> </tr> </tbody> </table>	X	Y	Z	≤ 3	≤ 2	$\leq t$	shall not reach to ITO		
X	Y	Z							
≤ 3	≤ 2	$\leq t$							
shall not reach to ITO									
 <p>Acceptable criterion</p> <table border="1"> <thead> <tr> <th>X</th> <th>Y</th> <th>Z</th> </tr> </thead> <tbody> <tr> <td>Disregard</td> <td>≤ 0.2</td> <td>$\leq t$</td> </tr> </tbody> </table>	X	Y	Z	Disregard	≤ 0.2	$\leq t$			
X	Y	Z							
Disregard	≤ 0.2	$\leq t$							
 <p>Acceptable criterion</p> <table border="1"> <thead> <tr> <th>X</th> <th>Y</th> <th>Z</th> </tr> </thead> <tbody> <tr> <td>≤ 5</td> <td>≤ 2</td> <td>$\leq t/3$</td> </tr> </tbody> </table>	X	Y	Z	≤ 5	≤ 2	$\leq t/3$			
X	Y	Z							
≤ 5	≤ 2	$\leq t/3$							

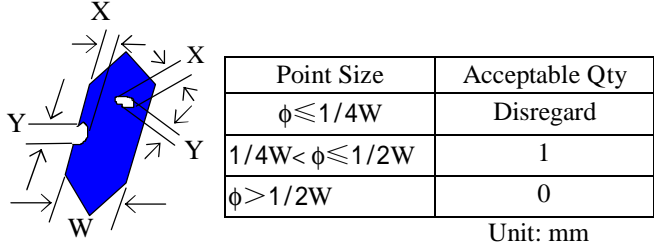
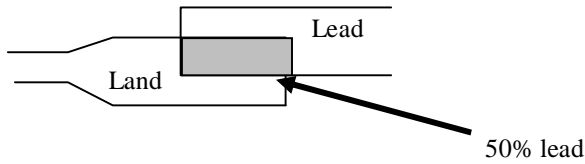
No.	Item	Criterion								
7	Segment pattern W = Segment width $\phi = (X+Y)/2$	<p>(1) Pin hole</p> <p>$\phi < 0.10\text{mm}$ is acceptable.</p>  <table border="1" data-bbox="868 409 1295 567"> <thead> <tr> <th>Point Size</th> <th>Acceptable Qty</th> </tr> </thead> <tbody> <tr> <td>$\phi \leq 1/4W$</td> <td>Disregard</td> </tr> <tr> <td>$1/4W < \phi \leq 1/2W$</td> <td>1</td> </tr> <tr> <td>$\phi > 1/2W$</td> <td>0</td> </tr> </tbody> </table> <p>Unit: mm</p>	Point Size	Acceptable Qty	$\phi \leq 1/4W$	Disregard	$1/4W < \phi \leq 1/2W$	1	$\phi > 1/2W$	0
Point Size	Acceptable Qty									
$\phi \leq 1/4W$	Disregard									
$1/4W < \phi \leq 1/2W$	1									
$\phi > 1/2W$	0									
8	Back-light	<p>(1) The color of backlight should be in match with the specification.</p> <p>(2) Not allow flickering</p>								
9	Soldering	<p>(1) Not allow heavy dirty and solder ball on PCB. (The size of dirty refer to point and dust defect)</p> <p>(2) Over 50% of lead should be soldered on Land.</p> 								
10	Wire	<p>(1) Copper wire should not be rusted</p> <p>(2) Not allow crack on copper wire connection.</p> <p>(3) Not allow reversing the position of the flat cable.</p> <p>(4) Not allow exposed copper wire inside the flat cable.</p>								
11*	PCB	<p>(1) Not allow screw rust or damage.</p> <p>(2) Not allow missing or wrong putting of component.</p>								

CONFIDENTIAL

CONFIDENTIAL

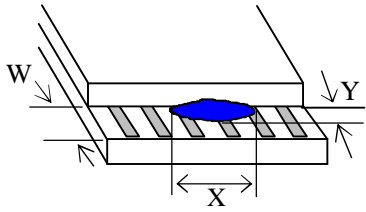
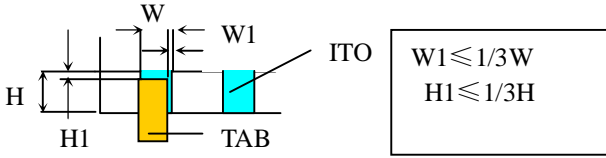
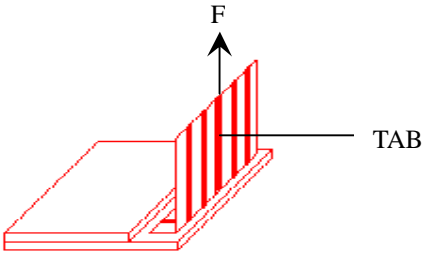
No	Item	Criterion
12	Protruded W: Terminal Width	 <p>Acceptable criteria: $Y \leq 0.4$</p>
13	TAB	<p>1. Position</p>  <p>ITO</p> <p>$W1 \leq 1/3 W$ $H1 \leq 1/3 H$</p> <p>2. TAB bonding strength test</p>  <p>$P (=F/TAB \text{ bonding width}) \geq 650gf/cm$,(speed rate: 1mm/min) 5pcs per SOA (shipment)</p>
14	Total no. of acceptable Defect	<p>A. Zone</p> <p>Maximum 2 minor non-conformities per one unit. Defect distance: each point to be separated over 10mm</p> <p>B. Zone</p> <p>It is acceptable when it is no trouble for quality and assembly in customer's end product.</p>

11.3 RELIABILITY OF LCM

Reliability test condition:

Item	Condition	Time (hrs)	Assessment
High temp. Storage	80°C	48	No abnormalities in functions and appearance
High temp. Operating	70°C	48	
Low temp. Storage	-30°C	48	
Low temp. Operating	-20°C	48	
Humidity	40°C/ 90%RH	48	
Temp. Cycle	0°C ← 25°C → 50°C (30 min ← 5 min → 30min)	10cycles	

Recovery time should be 24 hours minimum. Moreover, functions, performance and appearance shall be free from remarkable deterioration within 50,000 hours under ordinary operating and storage conditions room temperature (20±8°C), normal humidity (below 65% RH), and in the area not exposed to direct sun light.

11.4 PRECAUTION FOR USING LCD/LCM

LCD/LCM is assembled and adjusted with a high degree of precision. Do not attempt to make any alteration or modification. The followings should be noted.

GENERAL PRECAUTIONS:

1. LCD panel is made of glass. Avoid excessive mechanical shock or applying strong pressure onto the surface of display area.
2. The polarizer used on the display surface is easily scratched and damaged. Extreme care should be taken when handling. To clean dust or dirt off the display surface, wipe gently with cotton, or other soft material soaked with isopropyl alcohol, ethyl alcohol or trichlorotrifluoroethane, do not use water, ketone or aromatics and never scrub hard.
3. Do not tamper in any way with the tabs on the metal frame.
4. Do not make any modification on the PCB without consulting USMP
5. When mounting a LCM, make sure that the PCB is not under any stress such as bending or twisting. Elastomer contacts are very delicate and missing pixels could result from slight dislocation of any of the elements.
6. Avoid pressing on the metal bezel, otherwise the elastomer connector could be deformed and lose contact, resulting in missing pixels and also cause rainbow on the display.
7. Be careful not to touch or swallow liquid crystal that might leak from a damaged cell. Any liquid crystal spreads to skin or clothes, wash it off immediately with soap and water.

STATIC ELECTRICITY PRECAUTIONS:

1. CMOS-LSI is used for the module circuit; therefore operators should be grounded whenever he/she comes into contact with the module.
2. Do not touch any of the conductive parts such as the LSI pads; the copper leads on the PCB and the interface terminals with any parts of the human body.
3. Do not touch the connection terminals of the display with bare hand; it will cause disconnection or defective insulation of terminals.
4. The modules should be kept in anti-static bags or other containers resistant to static for storage.

CONFIDENTIAL

5. Only properly grounded soldering irons should be used.
6. If an electric screwdriver is used, it should be grounded and shielded to prevent sparks.
7. The normal static prevention measures should be observed for work clothes and working benches.
8. Since dry air is inductive to static, a relative humidity of 50-60% is recommended.

SOLDERING PRECAUTIONS:

1. Soldering should be performed only on the I/O terminals
2. Use soldering irons with proper grounding and no leakage.
3. Soldering temperature: $280^{\circ}\text{C} \pm 10^{\circ}\text{C}$
4. Soldering time: 3 to 4 second.
5. Use eutectic solder with resin flux filling.
6. If flux is used, the LCD surface should be protected to avoid spattering flux.
7. Flux residue should be removed.

OPERATION PRECAUTIONS:

1. The viewing angle can be adjusted by varying the LCD driving voltage V_o .
2. Since applied DC voltage causes electro-chemical reactions, which deteriorate the display, the applied pulse waveform should be a symmetric waveform such that no DC component remains. Be sure to use the specified operating voltage.
3. Driving voltage should be kept within specified range; excess voltage will shorten display life.
4. Response time increases with decrease in temperature.
5. Display color may be affected at temperatures above its operational range.
6. Keep the temperature within the specified range usage and storage. Excessive temperature and humidity could cause polarization degradation, polarizer peel-off or generate bubbles.
7. For long-term storage over 40°C is required, the relative humidity should be kept below 60%, and avoid direct sunlight.



US Micro Products

Electronic Products for the OEM

Los Angeles • Austin • New York • Orlando • Shenzhen

(800) 741-7755

www.usmicroproducts.com

Displays

US Micro Products is an industrial distributor specializing in engineered display solutions. We dedicate ourselves to providing the best in displays for the medical, industrial, gaming, automotive, aerospace, military, and consumer markets.

OLEDs



TFT Displays



Open Frame Monitors



Passive LCDs



Multitouch



As a customer, you benefit from our expert knowledge, support and service which allow quick selection and design-in of the best display for your application. On hand stock and demo boards facilitate quick access and evaluation to get you going fast. Our technical sales staff and experienced design engineers provide answers to your questions as well as engineered solutions to solve your display needs.

Peripheral Devices

Our full line of peripheral devices includes keyboards, trackballs, and printers. These rugged industrial products are designed to meet your demanding requirements and are available as both standard and custom solutions.

Keyboards



Trackballs



Aerospace Trackballs



Joysticks



Printers

